

## AS5002 Arcadium™ Pin Selectable Frequency Oscillator, 10 kHz to 350 MHz

The AS5002 Arcadium™ all-silicon oscillator utilizes proprietary frequency synthesis and sensor technologies to provide a quartz-free, MEMS-free, low jitter clock at any output frequency. The device is factory-programmed to have 3 selectable frequencies ranging from 10 kHz to 350 MHz with <0.026 ppb resolution and maintains low jitter across its operating range. The AS5002 uses on-chip temperature and strain sensors, and an advanced LC tank architecture to achieve excellent reliabilities even in high impact shock scenarios. AS5002's on-chip power supply filtering provides industry-leading power supply noise rejection, simplifying the task of generating low jitter clocks in noisy systems that use switched-mode power supplies. Offered in a variety of industry-standard packages, the AS5002 has a dramatically simplified supply chain that enables Aeonsemi to ship samples shortly after receipt of order. The AS5002 is factory-configurable for a wide variety of user specifications, including frequency, output format, and OE pin location. Specific configurations are factory programmed at time of shipment, eliminating the long lead times associated with custom oscillators. This process also guarantees 100% electrical testing of every device before shipment.

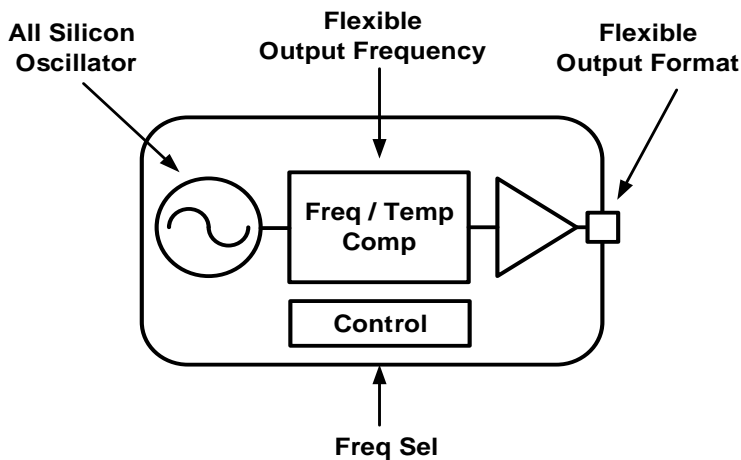

### KEY FEATURES

- Quartz-free and MEMS-free without mechanical moving parts
- Flexible output frequency and format; user selectable
  - Differential: 10 kHz to 350 MHz
  - LVCMOS: 10 kHz to 212.5 MHz
  - LVPECL, LVDS, CML, HCSSL, CMOS, or Dual CMOS output options
- Low jitter: 350 fs Typ RMS (12 kHz – 20 MHz)
- Compliant to PCIe Gen 1/2/3/4/5 jitter requirements
- 50 ppm stability (-40 to 85°C)
- Integrated LDO for on-chip power supply noise filtering
- Support continuous 1.8V to 3.3V V<sub>DD</sub> supply operation
- Industrial standard 3.2 x 5, 2.5 x 3.2 mm package footprints

### APPLICATIONS

- 1G/10G/40G/100G Ethernet
- Servers, switches, storage, NICs, search acceleration
- Test and measurement
- Clock and data recovery
- FPGA/ASIC clocking

### Pin Assignments

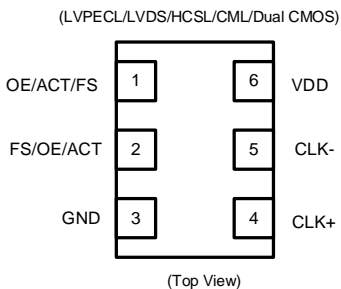

3.2 x 5 mm and 2.5 x 3.2 mm

Pin #	Descriptions
1, 2	Selectable via ordering option OE= Output Enable. Active High ACT = Device Active. Active High FS = Freq Select. Hi-Z, High or Low
3	GND = Ground
4	CLK+ = Clock output
5	CLK- = Complementary clock output
6	VDD = Power supply



## 1. Ordering Guide

The AS5002 Oscillator supports a variety of options including frequency, output format, and FS / OE / ACT pin location, as shown in the chart below. Specific device configurations are programmed into the part at time of shipment, and samples are available in 2 weeks.

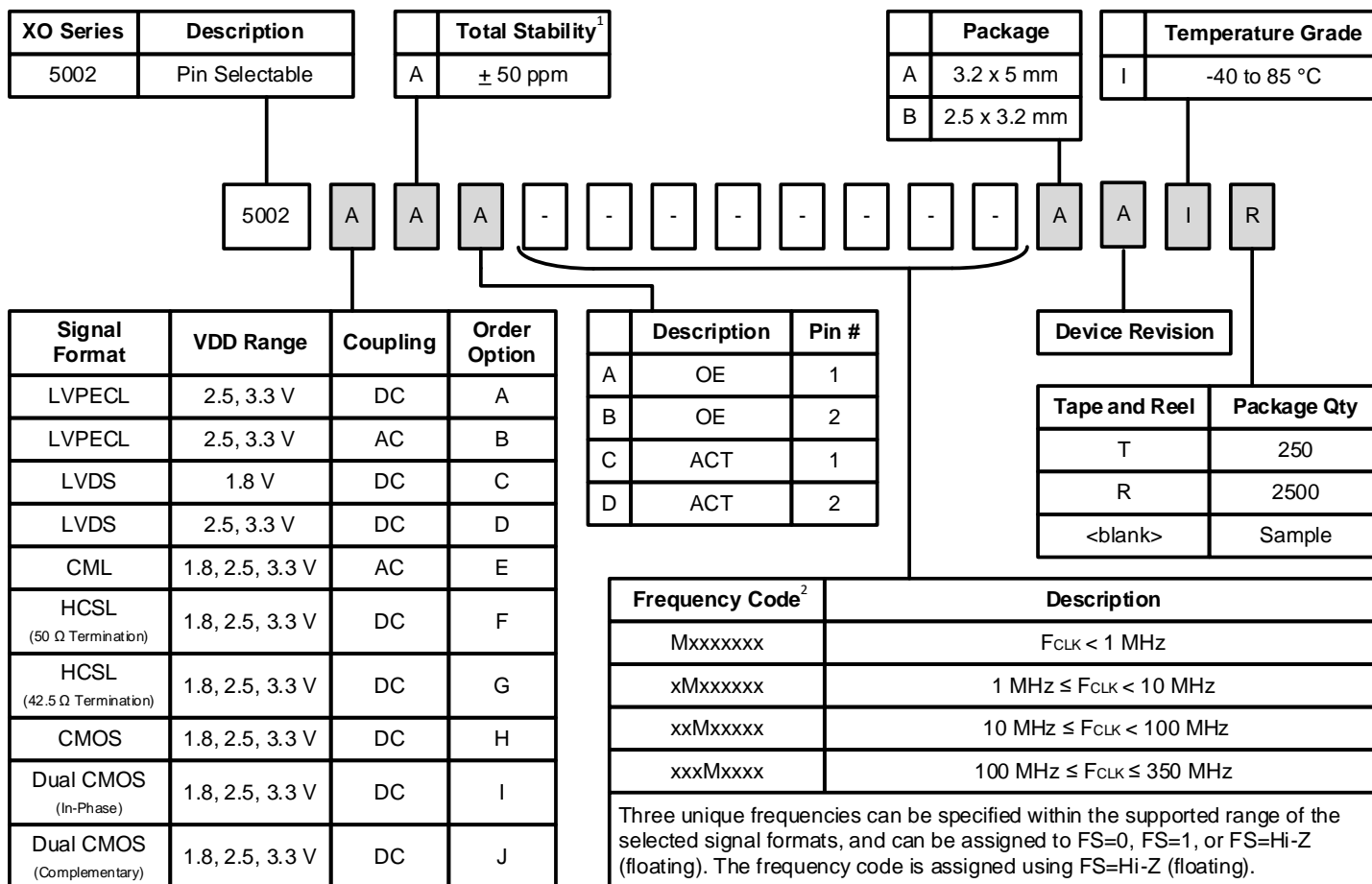

### Notes:

- Total stability includes temperature stability, initial accuracy, load pulling,  $V_{DD}$  variation, and 10 years aging at 40 °C.
- For example: 156.25 MHz = 156M250; 25 MHz = 25M0000.

## Control Pins

### 2.1. Overview

The AS5002 is a pin selectable oscillator that generates reference clocks with any output frequencies (10 kHz – 350 MHz), and any output formats (LVPECL, LVDS, CML, HCSL, CMOS, or Dual CMOS). Control pins, Pin 1 and Pin 2, of the AS5002 are designed as multi-functional input pins that support various functions, such as output enable (OE), device active (ACT) and frequency select (FS).

### 2.2. Configuration Selection

The on chip Non-Volatile Memory (NVM) stores three pre-programmed output frequencies and formats. It selects an output frequency and format using the frequency select pin (FS). Configurations can be preset at [aeonsemi.com/as5002/](http://aeonsemi.com/as5002/).

Table 2.1. shows an example of a configuration.

**Table 2.1. A Configuration Example with 3 Pre-Programmed Presets<sup>1</sup>**

Preset	FS (Pin 1 or Pin 2)	Output Frequency	Output Format
1	Low	156.25 MHz	LVDS
2	High-Z	74.25 MHz	Dual CMOS
3	High	50 MHz	LVC MOS

**Notes:**

- AS5002 supports an option of up to 9 different configurations, including FS, ACT, and OE features on the control pins. Contact [aeonsemi.com/contact-us/](http://aeonsemi.com/contact-us/) for the advanced configurations.

## 2. Electrical Specifications

**Table 3.1. Electrical Specifications**
 $V_{DD} = 1.8\text{ V}, 2.5\text{ or }3.3\text{ V} \pm 5\%$ ,  $T_A = -40\text{ to }85\text{ }^\circ\text{C}$ 

Parameter	Symbol	Test Condition/Comment	Min	Typ	Max	Unit
Temperature Range	$T_A$		-40	—	85	$^\circ\text{C}$
Frequency Range	$F_{CLK}$	LVPECL, LVDS, CML, HCSL	0.01	—	350	MHz
		CMOS, Dual CMOS	0.01	—	212.5	MHz
Supply Voltage	$V_{DD}$		1.71		3.47	V
Supply Current	$I_{DD}$	Tristate Hi-Z (OE = 0, output disabled)	—	40	50	mA
		Ready State (ACT = 0, standby mode)	—	1	2	mA
		LVPECL (DC-Coupled)	—	70	80	mA
		LVPECL (AC-Coupled)	—	60	70	mA
		LVDS	—	45	55	mA
		HCSL	—	60	70	mA
		CML	—	60	70	mA
		CMOS	—	40	55	mA
		Dual CMOS	—	50	60	mA
Total Stability <sup>1</sup>	$F_{STAB}$	Frequency stability	-50	—	50	ppm
Rise/Fall Time (20% to 80% $V_{PP}$ )	$T_R/T_F$	LVPECL/LVDS/CML	—	—	350	ps
		CMOS / Dual CMOS ( $C_L = 5\text{ pF}$ )	—	0.5	1.5	ns
		HCSL, $F_{CLK} > 50\text{ MHz}$	—	—	550	ps
Duty Cycle	$D_C$	All formats	45	—	55	%
Output Enable (OE) <sup>2</sup>	$V_{IH}$		$0.7 \times V_{DD}$	—	—	V
	$V_{IL}$		—	—	$0.3 \times V_{DD}$	V
	$T_D$	Output Disable Time, $F_{CLK} > 10\text{ MHz}$	—	—	3	$\mu\text{s}$
	$T_E$	Output Enable Time, $F_{CLK} > 10\text{ MHz}$	—	—	20	$\mu\text{s}$
Frequency Select (FS)	$V_{IH}$		$0.7 \times V_{DD}$	—	—	V
	$V_{IL}$		—	—	$0.3 \times V_{DD}$	V
Powerup Time	$t_{OSC}$	Time from $0.9 \times V_{DD}$ until output frequency ( $F_{CLK}$ ) within spec	—	—	4	ms
LVPECL Output Option <sup>3</sup> (DC-Coupled)	$V_{OC}$	Mid-level	$V_{DD} - 1.55$	—	$V_{DD} - 1.25$	V
	$V_O$	Swing (diff)	1.4	—	1.85	$V_{PP}$
LVPECL Output Option <sup>3</sup> (AC-Coupled)	$V_O$	Swing (diff)	1.4	—	1.85	$V_{PP}$

Parameter	Symbol	Test Condition/Comment	Min	Typ	Max	Unit
LVDS Output Option <sup>3</sup> (DC-Coupled)	V <sub>OC</sub>	Mid-level (2.5 V, 3.3 V V <sub>DD</sub> )	1.125	1.20	1.275	V
		Mid-level (1.8 V V <sub>DD</sub> )	0.795	0.85	0.905	V
	V <sub>O</sub>	Swing (diff)	0.5	0.82	0.96	V <sub>PP</sub>
HCSL Output Option <sup>5</sup> (R <sub>term</sub> = 50 Ω; DC-Coupled)	V <sub>OH</sub>	Output voltage high	695	815	935	mV
	V <sub>OL</sub>	Output voltage low	0	5	10	mV
HCSL Output Option <sup>5</sup> (R <sub>term</sub> = 42.5 Ω; DC-Coupled)	V <sub>OH</sub>	Output voltage high	695	820	945	mV
	V <sub>OL</sub>	Output voltage low	0	5	10	mV
CML Output Option <sup>4</sup> (AC-Coupled)	V <sub>O</sub>	Swing (diff)	0.725	0.8	0.89	V <sub>PP</sub>
CMOS Output Option	V <sub>OH</sub>	I <sub>OH</sub> = 8/6/4 mA for 3.3/2.5/1.8V V <sub>DD</sub>	0.83 × V <sub>DD</sub>	—	—	V
	V <sub>OL</sub>	I <sub>OL</sub> = 8/6/4 mA for 3.3/2.5/1.8V V <sub>DD</sub>	—	—	0.17 × V <sub>DD</sub>	V

**Notes:**

2. Total Stability includes temperature stability, initial accuracy, load pulling, V<sub>DD</sub> variation, and aging for 10 years at 40°C.
3. OE/ACT includes a 50 kΩ pull-up to V<sub>DD</sub> for OE active high. Includes a 50 kΩ pull-down to GND for OE/ACT active low. NC (No Connect) pins include a 50 kΩ pull-down to GND.
4. R<sub>term</sub> = 50 Ω to V<sub>DD</sub> – 2.0 V (see Figure 4.1).
5. R<sub>term</sub> = 100 Ω (differential) (see Figure 4.2).
6. R<sub>term</sub> = 50 Ω to GND (see Figure 4.2).

**Table 3.2. Clock Output Phase Jitter and PSRR**

V<sub>DD</sub> = 1.8 V, 2.5 or 3.3 V ± 5%, T<sub>A</sub> = -40 to 85 °C

Parameter	Symbol	Test Condition/Comment	Min	Typ	Max	Unit
Phase Jitter (RMS, 12 kHz - 20 MHz) <sup>1,2</sup> F <sub>CLK</sub> ≥ 10 MHz	φ <sub>J</sub>	Differential Formats	—	350	750	fs
		CMOS, Dual CMOS	—	350	—	fs
Phase Jitter (RMS, 50 kHz - 20 MHz) F <sub>CLK</sub> ≥ 156.25 MHz	φ <sub>J</sub>	Differential Formats	—	150	250	fs
		CMOS, Dual CMOS	—	100	—	fs
Spurs Induced by External Power Supply Noise, 50 mVpp Ripple. LVDS 156.25 MHz Output V <sub>DD</sub> = 1.8 V	PSRR	100 kHz sine wave	—	-76	—	dBc
		200 kHz sine wave	—	-75	—	
		500 kHz sine wave	—	-75	—	
		1 MHz sine wave	—	-75	—	
Spurs Induced by External Power Supply Noise, 50 mVpp Ripple. LVDS 156.25 MHz Output V <sub>DD</sub> = 2.5 or 3.3 V	PSRR	100 kHz sine wave	—	-83	—	dBc
		200 kHz sine wave	—	-83	—	
		500 kHz sine wave	—	-83	—	
		1 MHz sine wave	—	-82	—	

**Note:**

1. Applies to output frequency: 50, 100, 156.25, 212.5, 350 MHz.
2. Guaranteed by characterization. Jitter inclusive of any spurs.

**Figure 3.1. Phase Noise at 156.25 MHz**

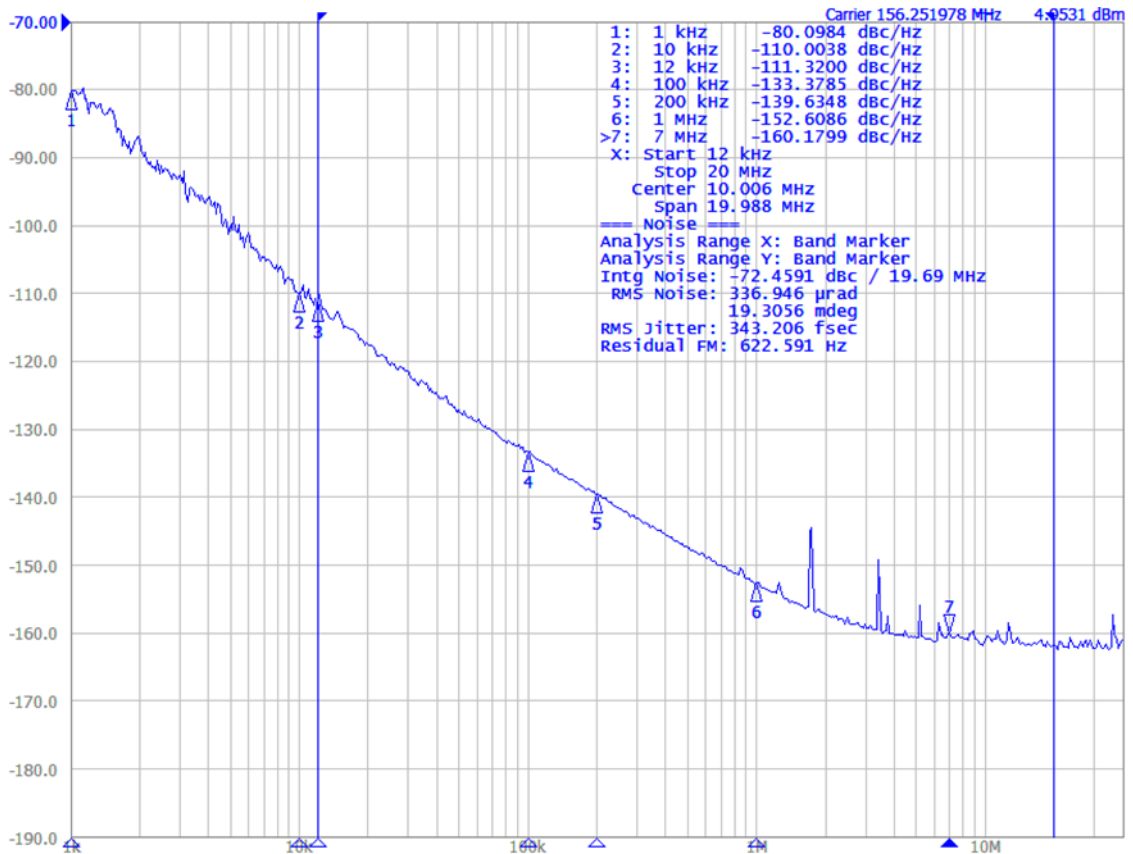

**Table 3.3. Environmental Compliance and Package Information**

Parameter	Test Condition
Moisture Sensitivity Level	1
<b>Note:</b> For additional product information not listed in the data sheet (e.g. RoHS Certifications, MSDS data, qualification data, REACH Declarations, ECCN codes, etc.), contact <a href="http://aeonsemi.com/contact-us/">aeonsemi.com/contact-us/</a>	

**Table 3.4. Thermal Conditions**

Package	Parameter	Symbol	Test Condition	Value	Unit
3.2 x 5 mm, 6-pin DFN	Thermal Resistance Junction to Ambient	$\Theta_{JA}$	Still Air	105	°C/W
	Thermal Resistance Junction to Board	$\Theta_{JB}$	Still Air	81	°C/W
	Max Junction Temperature	$T_J$	Still Air	125	°C
2.5 x 3.2 mm, 6-pin DFN	Thermal Resistance Junction to Ambient	$\Theta_{JA}$	Still Air	108	°C/W
	Thermal Resistance Junction to Board	$\Theta_{JB}$	Still Air	84	°C/W
	Max Junction Temperature	$T_J$	Still Air	125	°C

**Table 3.5. Absolute Maximum Ratings<sup>1</sup>**

Parameter	Symbol	Rating	Unit
Maximum Operating Temperature	$T_{AMAX}$	85	°C
Storage Temperature	$T_S$	-55 to 125	°C
Supply Voltage	$V_{DD}$	-0.5 to 3.8	V
Input Voltage	$V_{IN}$	-0.5 to $V_{DD} + 0.3$	V
ESD HBM (JESD22-A114)	HBM	4.0	kV
Solder Temperature <sup>2</sup>	$T_{PEAK}$	260	°C
Solder Time at $T_{PEAK}$ <sup>2</sup>	$T_P$	20 - 40	sec

**Notes:**

- Stresses beyond those listed in this table may cause permanent damage to the device. Functional operation specification compliance is not implied at these conditions. Exposure to maximum rating conditions for extended periods may affect device reliability.
- The device is compliant with JEDEC J-STD-020.

### 3. CMOS Buffer and Output Terminations

Dual CMOS output format ordering options support either complementary or in-phase signals for two identical frequency outputs. This feature enables replacement of multiple XOs with a single AS5001 device.

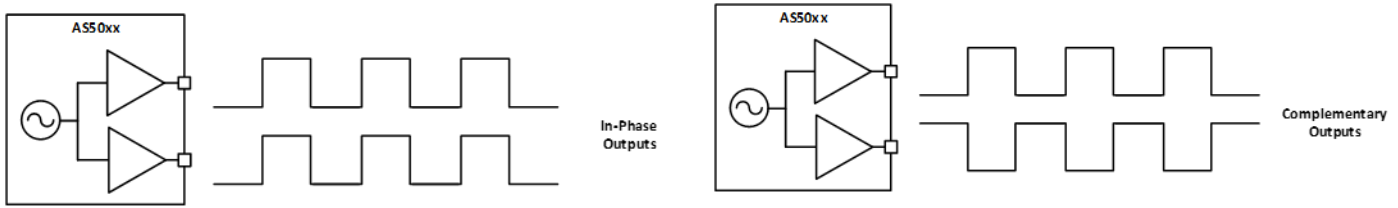
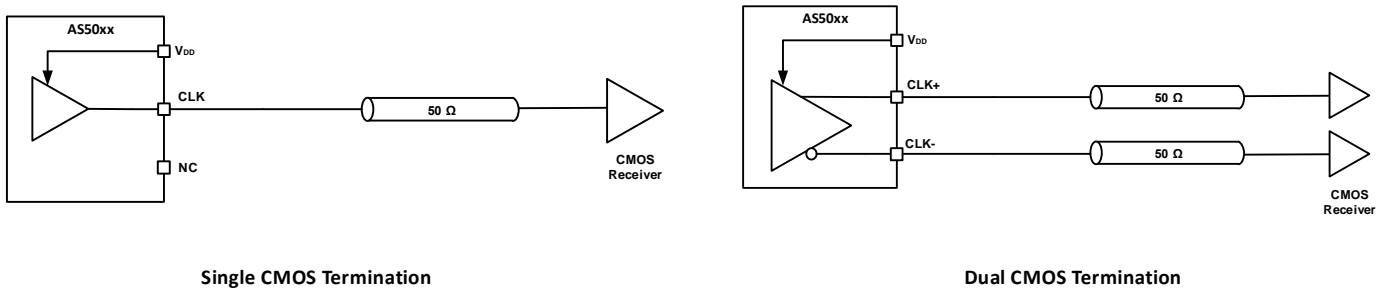

Figure 4.1. Integrated 1:2 CMOS Buffer Supports In-Phase or Complementary Outputs



Single CMOS Termination

Dual CMOS Termination

Figure 4.2. CMOS Output Terminations



## 4. Recommended Output Terminations

The output drivers support AC-coupled or DC-coupled terminations as shown in figures below.

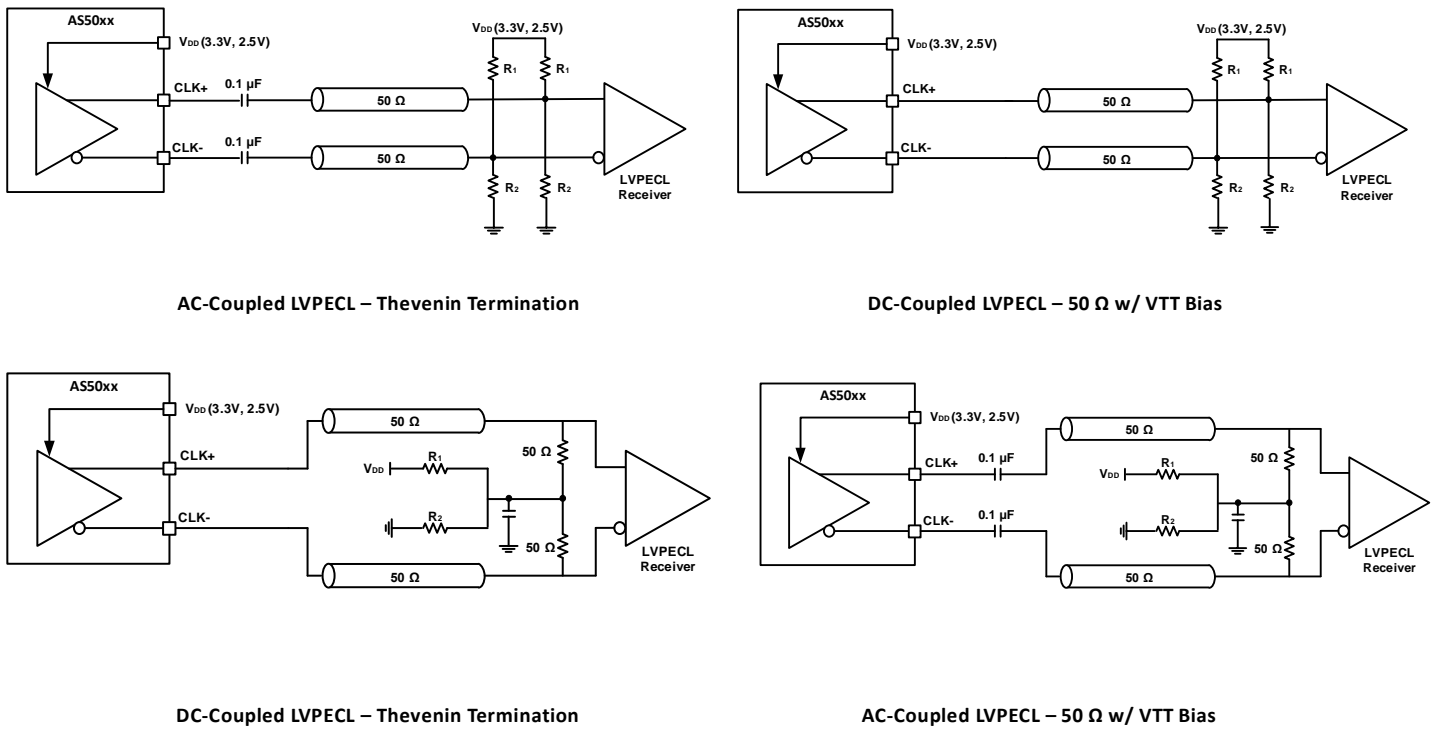

Termination Resistor Values		
V <sub>DD</sub>	R1	R2
3.3 V	127 Ω	82.5 Ω
2.5 V	250 Ω	62.5 Ω

**Figure 5.1. LVPECL Output Terminations**

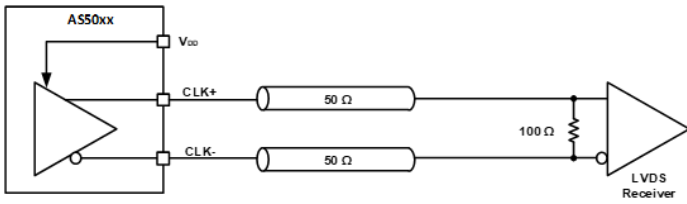

DC-Coupled LVDS

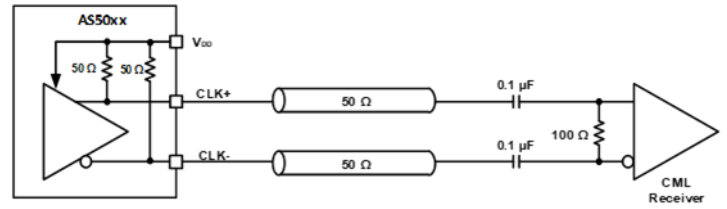

AC-Coupled CML

Figure 5.2. LVDS / CML Output Terminations

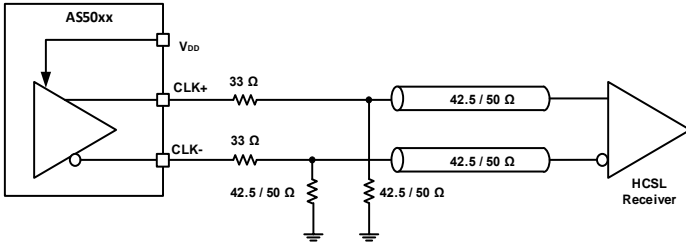

Source Terminated HCSL

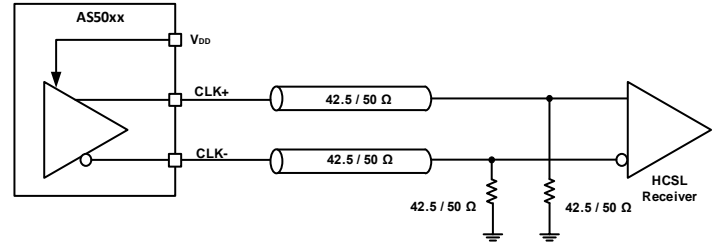

Destination Terminated HCSL

Figure 5.3. HCSL Output Terminations

## 5. Package Outline

### 6.1. Package Outline (3.2 x 5 mm)

The figure below illustrates the package details for the 3.2 x 5 mm AS5002. The table below lists the values for the dimensions shown in the illustration.

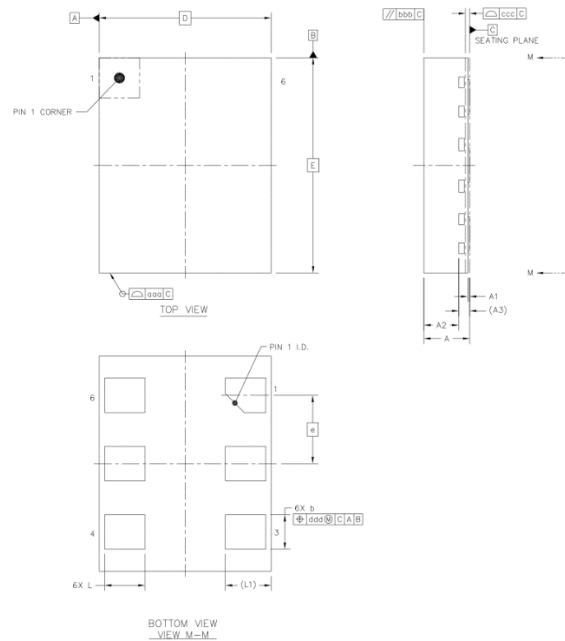

Figure 6.1. AS5002 (3.2 x 5 mm) Outline Diagram

Table 6.1. Package Diagram Dimensions (mm)

Dimension	Min	Nom	Max
A	0.8	0.85	0.9
A1	0	0.035	0.05
A2	--	0.65	--
A3		0.203 REF	
b	0.59	0.64	0.69
D		3.2 BSC	
E		4 BSC	
e		1.27 BSC	
L	0.7	0.75	0.8
L1		0.85 REF	
aaa		0.1	
bbb		0.1	
ccc		0.08	
ddd		0.1	

#### Notes:

1. All dimensions shown are in millimeters (mm) unless otherwise noted.
2. Dimensioning and Tolerancing per ANSI Y14.5M-1994.

## 6.2. Package Outline (2.5 x 3.2 mm)

The figure below illustrates the package details for the 2.5 x 3.2 mm AS5002. The table below lists the values for the dimensions shown in the illustration.

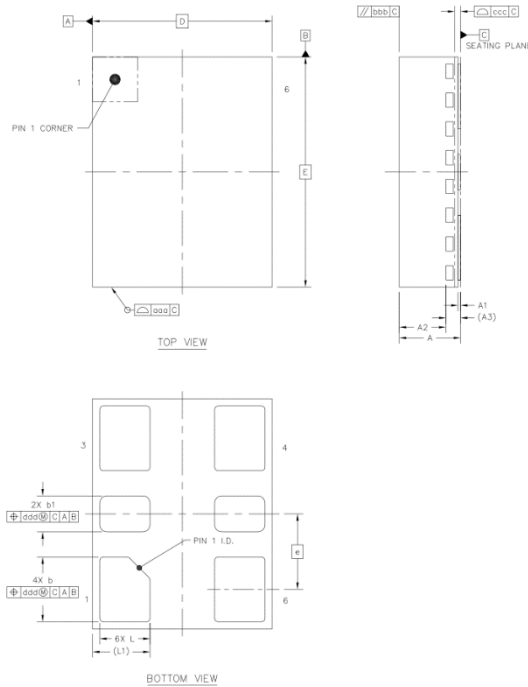

Figure 6.2. AS5002 (2.5 x 3.2 mm) Outline Diagram

Table 6.2. Package Diagram Dimensions (mm)

Dimension	Min	Nom	Max
A	0.8	0.85	0.9
A1	0	0.035	0.05
A2	---	0.65	---
A3	0.203 REF		
b	0.85	0.9	0.95
b1	0.45	0.5	0.55
D	2.5 BSC		
E	3.2 BSC		
e	1.05 BSC		
L	0.65	0.7	0.75
aaa	0.1		
bbb	0.1		
ccc	0.08		
ddd	0.1		

### Notes:

1. The dimensions in parentheses are reference.
2. All dimensions in millimeters (mm).
3. Dimensioning and Tolerancing per ANSI Y14.5M-1994.

## 6. PCB Land Pattern (3.2 x 5 mm and 2.5 x 3.2 mm)

The figure below illustrates the PCB land pattern for the AS5002. The table below lists the values for the dimensions shown in the illustration.

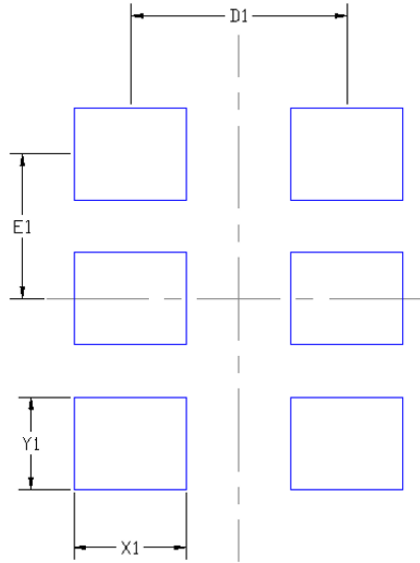

Figure 7.1. AS5002 (3.2 x 5 mm and 2.5 x 3.2 mm) PCB Land Pattern

Table 7.1. PCB Land Pattern Dimensions (mm)

Dimension	Description	3.2 x 5 mm Package Value (mm)	2.5 x 3.2 mm Package Value (mm)
X1	Width - leads on long sides	0.75	0.7
Y1	Height - leads on long sides	0.64	0.9, 0.5
D1	Pitch in X directions of XLY1 leads	2.25	1.6
E1	Lead pitch XLY1 leads	1.27	1.05

**Notes:** The following notes and stencil design are shared as recommendations only. A customer or user may find it necessary to use different parameters and fine-tune their SMT process as required for their application and tooling.

### General

1. All dimensions shown are in millimeters (mm) unless otherwise noted.
2. Dimensioning and Tolerancing is per the ANSI Y14.5M-1994 specification.
3. This Land Pattern Design is based on the IPC-7351 guidelines.
4. All dimensions shown are at Maximum Material Condition (MMC). Least Material Condition (LMC) is calculated based on a Fabrication Allowance of 0.05 mm.

### Solder Mask Design

1. All metal pads are to be non-solder mask defined (NSMD). Clearance between the solder mask and the metal pad is to be 60  $\mu\text{m}$  minimum, all the way around the pad.

### Stencil Design

1. A stainless steel, laser-cut and electro-polished stencil with trapezoidal walls should be used to assure good solder paste release.
2. The stencil thickness should be 0.125 mm (5 mils).
3. The ratio of stencil aperture to land pad size should be 0.8:1 for the pads.

### Card Assembly

1. A No-Clean, Type-3 solder paste is recommended.
2. The recommended card reflow profile is per the JEDEC/IPC J-STD-020 specification for Small Body Components.

## 7. Top Marking (3.2 x 5 mm and 2.5 x 3.2 mm)

The figure below illustrates the mark specification for the AS5002. The table below lists the line information.

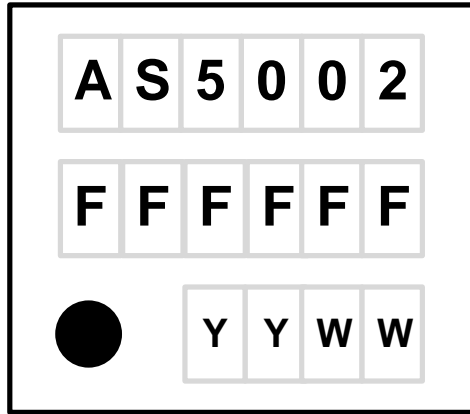

Figure 8.1. AS5002 Top Mark

Table 8.1. AS5002 Top Mark Description

Line	Position	Description
1	1–6	Device Name
2	<b>Trace Code</b>	
	1–6	Field ID (Default = 000000)
3	Position 1	Pin 1 orientation mark (dot)
	Position 2–3	Year (last two digits of the year), to be assigned by assembly site (ex: 2017 = 17)
	Position 4–5	Calendar Work Week number (1–53), to be assigned by assembly site

## 8. Revision History

### Revision 0.92

Feb 2021

- Corrected the PCB Land Pattern description
- Corrected the Top Mark description
- Updated the Ordering Guide
- Added the description of the control pins

### Revision 0.91

Oct 2020

- Removed Note 3 "IEEE802.3-2005 10GbE jitter mask." from Table 2.2
- Corrected figure # of section 3 and section

### Revision 0.9

Sept 2020

- Initial release