

## AS5002 Arcadium™ Pin Selectable Frequency Oscillator, 10 kHz to 350 MHz

The AS5002 Arcadium™ all-silicon oscillator utilizes proprietary frequency synthesis and sensor technologies to provide a quartz-free, MEMS-free, low jitter clock at any output frequency. The device is factory-programmed to have 3 selectable frequencies ranging from 10 kHz to 350 MHz with <math><0.026</math> ppb resolution and maintains low jitter across its operating range. The AS5002 uses on-chip temperature and strain sensors, and an advanced LC tank architecture to achieve excellent reliabilities even in high impact shock scenarios.

AS5002's on-chip power supply filtering provides industry-leading power supply noise rejection, simplifying the task of generating low jitter clocks in noisy systems that use switched-mode power supplies. Offered in a variety of industry-standard packages, the AS5002 has a dramatically simplified supply chain that enables Aeonsemi to ship samples shortly after receipt of order. The AS5002 is factory-configurable for a wide variety of user specifications, including frequency, output format, and OE pin location. Specific configurations are factory programmed at time of shipment, eliminating the long lead times associated with custom oscillators. This process also guarantees 100% electrical testing of every device before shipment.

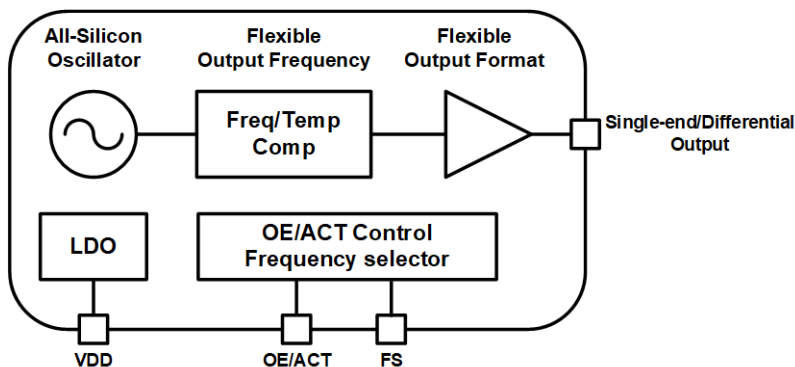

### Pin Assignments

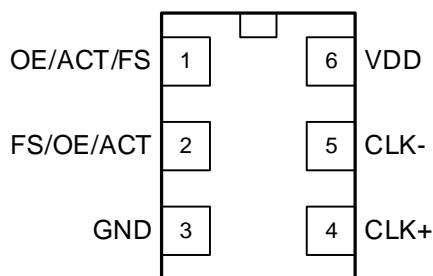

Top view

5032 and 3225 package



### KEY FEATURES

- Quartz-free and MEMS-free without mechanical moving parts
- Flexible output frequency and format; user selectable
- Differential: 10 kHz to 350 MHz
- CMOS: 10 kHz to 212.5 MHz
- LVPECL, LVDS, CML, HCSL, CMOS, or Dual CMOS output options
- Low jitter: 350 fs Typ RMS (12 kHz – 20 MHz)
- Compliant to PCIe Gen 1/2/3/4/5/6 jitter requirements
- Temperature stability:
  - $\pm 12$  ppm (0 to 70 °C)
  - $\pm 20$  ppm (-20 to 85 °C)
  - $\pm 35$  ppm (-40 to 85 °C)
  - $\pm 35$  ppm (-40 to 105 °C)
- Integrated LDO for on-chip power supply noise filtering
- Support 1.8V, 2.5V, 3.3V  $V_{DD}$  power supply operation
- Industrial standard 3225 and 5032 package footprints

### APPLICATIONS

- 1G/10G/40G/100G/200G Ethernet
- Servers, switches, storage, NICs, search acceleration
- Test and measurement
- Clock and data recovery
- FPGA/ASIC clocking

Pin #	Descriptions
1, 2	Selectable via ordering option OE = Output Enable. Active High ACT = Device Active. Active High FS = Freq selector. Hi-z, High or Low
3	GND = Ground
4	CLK+ = Clock output
5	CLK- = Complementary clock output
6	VDD = Power supply

## 1. Ordering Guide

The AS5002 Oscillator supports a variety of options including frequency, output format, and FS / OE / ACT pin location, as shown in the chart below. Specific device configurations are programmed into the part at time of shipment, and samples are available in 2 weeks.

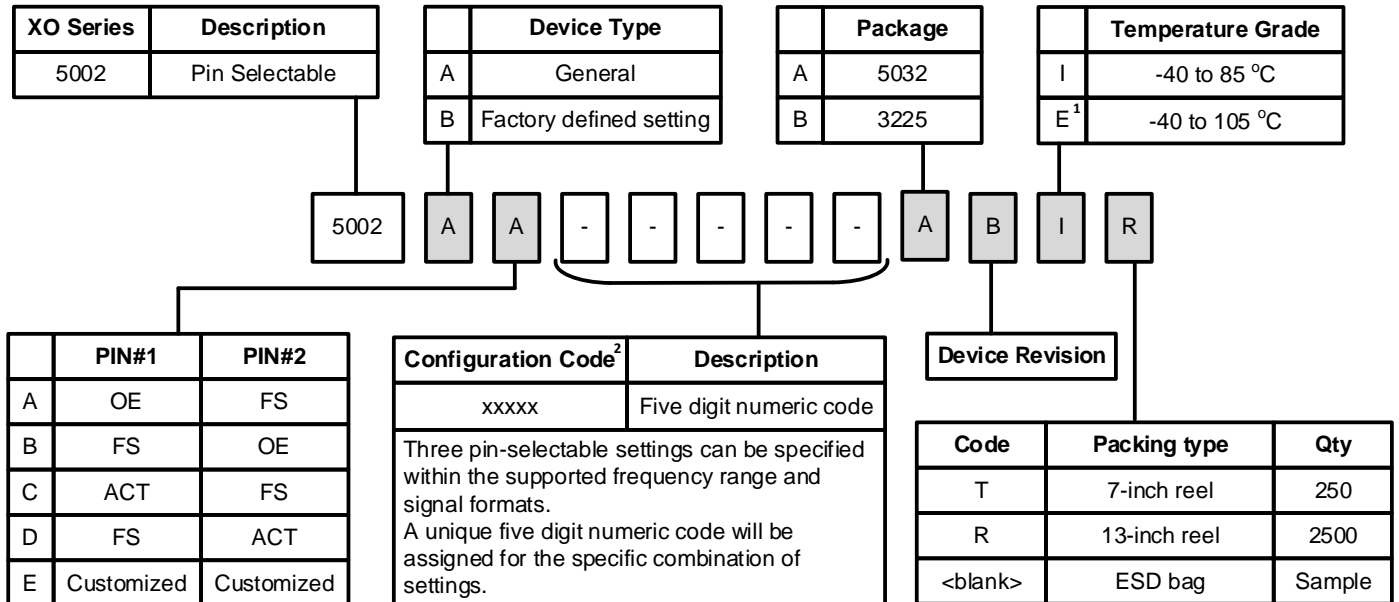

**Notes:**

1. Contact [aeonsemi.com/contact\\_us](http://aeonsemi.com/contact_us) for advanced -40~105°C option.
2. The five-digit numeric code is an identification of the configurations. Check the datasheet appendix for the details

## 2. Control Pins

### 2.1. Overview

The AS5002 is a pin selectable oscillator that generates reference clocks with any output frequencies (10 kHz – 350 MHz), and any output formats (LVPECL, LVDS, CML, HCSL, CMOS, or Dual CMOS). Control pins, Pin 1 and Pin 2, of the AS5002 are designed as multi-functional input pins that support various functions, such as output enable (OE), device active (ACT) and frequency select (FS).

### 2.2. Configuration Selection

The on chip Non-Volatile Memory (NVM) stores three pre-programmed output frequencies and formats. It selects an output frequency and format using the frequency select pin (FS). Configurations can be preset at [aeonsemi.com/as5002/](http://aeonsemi.com/as5002/).

Table 2.1. shows an example of a configuration.

**Table 2.1. A Configuration Example with 3 Pre-Programmed Presets**

Preset	FS (Pin 1 or Pin 2)	Output Frequency	Output Format
1	Low	156.25 MHz	LVDS
2	Hi-Z	74.25 MHz	Dual CMOS
3	High	50 MHz	LVC MOS

**Notes:**

AS5002 supports options of up to 9 different configurations, VCXO and SSC (Spread Spectrum Clock) features on the control pins. Contact [aeonsemi.com/contact-us/](http://aeonsemi.com/contact-us/) for the advanced configurations.

### 3. Electrical Specifications

**Table 3.1. Electrical Specifications**
 $V_{DD} = 1.8\text{ V}, 2.5\text{ or }3.3\text{ V} \pm 5\%$ ,  $T_A = -40\text{ to }105\text{ }^\circ\text{C}$ 

Parameter	Symbol	Test Condition/Comment	Min	Typ	Max	Unit
Temperature Range	$T_A$		-40	—	105	$^\circ\text{C}$
Frequency Range	$F_{CLK}$	LVPECL, LVDS, CML, HCSL	0.01	—	350	MHz
		CMOS	0.01	—	212.5	MHz
Supply Voltage	$V_{DD}$		1.71	—	3.47	V
Supply Current ( $F_{CLK} = 50\text{ MHz}$ )	$I_{DD}$	Tristate Hi-Z (OE = 0)	—	40	50	mA
		Ready State (ACT = 0)	—	1	2	mA
		LVPECL (Standard)	—	70	80	mA
		LVPECL (Self-Biased)	—	60	70	mA
		LVDS	—	45	55	mA
		HCSL	—	60	70	mA
		CML	—	60	70	mA
		Single CMOS	—	40	55	mA
		Dual CMOS	—	50	60	mA
Temperature Stability <sup>1</sup>	$F_{STAB}$	0 to +70 $^\circ\text{C}$	-12	—	+12	ppm
		-20 to +85 $^\circ\text{C}$	-20	—	+20	ppm
		-40 to +85 $^\circ\text{C}$	-35	—	+35	ppm
		-40 to +105 $^\circ\text{C}$ <sup>3</sup>	-35	—	+35	ppm
Frequency offset <sup>2</sup>	$F_{OFFSET}$	0 to +70 $^\circ\text{C}$	-23	—	+18	ppm
		-20 to +85 $^\circ\text{C}$	-21	—	+18	ppm
		-40 to +85 $^\circ\text{C}$	-20	—	+20	ppm
		-40 to +105 $^\circ\text{C}$ <sup>3</sup>	-22	—	+20	ppm
Rise/Fall Time (20% to 80% $V_{PP}$ )	$T_R/T_F$	LVPECL / LVDS / CML	—	—	350	ps
		CMOS ( $C_L = 5\text{ pF}$ )	—	0.5	1.5	ns
		HCSL, $F_{CLK} > 50\text{ MHz}$	—	—	550	ps
Duty Cycle	DC	All formats	45	—	55	%
Output Enable (OE) <sup>4</sup>	$V_{IH}$	—	$0.7 \times V_{DD}$	—	—	V
	$V_{IL}$	—	—	—	$0.3 \times V_{DD}$	V
	$T_D$	Output Disable Time, $F_{CLK} > 10\text{ MHz}$	—	—	3	$\mu\text{s}$
	$T_E$	Output Enable Time, $F_{CLK} > 10\text{ MHz}$	—	—	20	$\mu\text{s}$
Output Enable (ACT) <sup>4</sup>	$V_{IH}$	—	$0.7 \times V_{DD}$	—	—	V
	$V_{IL}$	—	—	—	$0.3 \times V_{DD}$	V
	$T_D$	Output Disable Time, $F_{CLK} > 10\text{ MHz}$	—	—	3	$\mu\text{s}$
	$T_S$	Device standby time, $F_{CLK} > 10\text{ MHz}$	—	—	40	$\mu\text{s}$
	$T_E$	Output Enable Time, $F_{CLK} > 10\text{ MHz}$	—	—	400	$\mu\text{s}$
Frequency Select (FS)	$V_{IH}$	—	$0.7 \times V_{DD}$	—	—	V
	$V_{IL}$	—	—	—	$0.3 \times V_{DD}$	V
Powerup Time	$T_{OSC}$	Time from $0.9 \times V_{DD}$ until output frequency ( $F_{CLK}$ ) within spec	—	—	4	ms

Parameter	Symbol	Test Condition/Comment	Min	Typ	Max	Unit
LVPECL Output Option <sup>5</sup> (Standard)	V <sub>OC</sub>	Mid-level	V <sub>DD</sub> -1.55	V <sub>DD</sub> -1.4	V <sub>DD</sub> -1.25	V
	V <sub>O</sub>	Swing (diff)	1.35	1.6	1.85	V <sub>PP</sub>
LVPECL Output Option <sup>5</sup> (Self-Biased)	V <sub>O</sub>	Swing (diff)	1.35	1.6	1.85	V <sub>PP</sub>
LVDS Output Option <sup>6</sup>	V <sub>OC</sub>	Mid-level (2.5 V, 3.3 V V <sub>DD</sub> )	1.125	1.20	1.275	V
		Mid-level (1.8 V V <sub>DD</sub> )	0.78	0.85	0.92	V
	V <sub>O</sub>	Swing (diff)	0.64	0.8	0.96	V <sub>PP</sub>
HCSL Output Option <sup>7</sup> (R <sub>term</sub> = 50 Ω)	V <sub>OC</sub>	Mid-level	0.35	0.4	0.45	V
	V <sub>O</sub>	Swing (diff)	1.28	1.6	1.92	V <sub>PP</sub>
HCSL Output Option <sup>7</sup> (R <sub>term</sub> = 42.5 Ω)	V <sub>OC</sub>	Mid-level	0.35	0.4	0.45	V
	V <sub>O</sub>	Swing (diff)	1.29	1.62	1.94	V <sub>PP</sub>
CML Output Option	V <sub>OC</sub>	Mid-level	V <sub>DD</sub> -0.35	V <sub>DD</sub> -0.4	V <sub>DD</sub> -0.45	V
	V <sub>O</sub>	Swing (diff)	1.28	1.6	1.92	V <sub>PP</sub>
CMOS Output Option	V <sub>OH</sub>	I <sub>OH</sub> = 8/6/4 mA for 3.3/2.5/1.8V V <sub>DD</sub>	0.83×V <sub>DD</sub>	—	—	V
	V <sub>OL</sub>	I <sub>OL</sub> = 8/6/4 mA for 3.3/2.5/1.8V V <sub>DD</sub>	—	—	0.17×V <sub>DD</sub>	V

**Notes:**

1. Frequency / temperature characteristics with offset removed.
2. Inclusive of initial frequency tolerance at 25°C, 10-year aging at 25°C, and variations over supply voltage, load and humidity after soldering-reflow shift settles.
3. Contact [aeonsemi.com/contact\\_us](http://aeonsemi.com/contact_us) for advanced -40~105°C option.
4. OE/ACT includes a 50 kΩ pull-up to V<sub>DD</sub> for OE/ACT active high. NC (No Connect) pin includes a 50 kΩ pull-down to GND.
5. R<sub>term</sub> = 50 Ω to V<sub>DD</sub> - 2.0 V (see Figure 5.1. )
6. R<sub>term</sub> = 100 Ω (differential) (see Figure 5.2. )
7. R<sub>term</sub> = 50/42.5 Ω to GND (see Figure 5.4. )

Table 3.2. Clock Output Phase Jitter and PSRR

V<sub>DD</sub> = 1.8 V, 2.5 or 3.3 V ± 5%, T<sub>A</sub> = -40 to 105 °C

Parameter	Symbol	Test Condition/Comment	Min	Typ	Max	Unit
Phase Jitter (RMS, 12 kHz - 20 MHz) <sup>1,2</sup> F <sub>CLK</sub> ≥ 10 MHz	φ <sub>J</sub>	Differential Formats	—	350	750	fs
		CMOS, Dual CMOS	—	350	—	fs
Phase Jitter (RMS, 50 kHz - 20 MHz) F <sub>CLK</sub> ≥ 100 MHz	φ <sub>J</sub>	Differential Formats	—	150	250	fs
		CMOS, Dual CMOS	—	100	—	fs
Spurs Induced by External Power Supply Noise 50 mV <sub>PP</sub> Ripple LVDS 156.25 MHz Output V <sub>DD</sub> = 1.8 V	PSRR	100 kHz sine wave	—	-76	—	dBc
		200 kHz sine wave	—	-75	—	
		500 kHz sine wave	—	-75	—	
		1 MHz sine wave	—	-75	—	
Spurs Induced by External Power Supply Noise 50 mV <sub>PP</sub> Ripple LVDS 156.25 MHz Output V <sub>DD</sub> = 2.5 or 3.3 V	PSRR	100 kHz sine wave	—	-83	—	dBc
		200 kHz sine wave	—	-83	—	
		500 kHz sine wave	—	-83	—	
		1 MHz sine wave	—	-82	—	

**Notes:**

1. Applies to output frequency: 50, 100, 156.25, 212.5, 350 MHz.
2. Guaranteed by characterization. Jitter inclusive of any spurs.

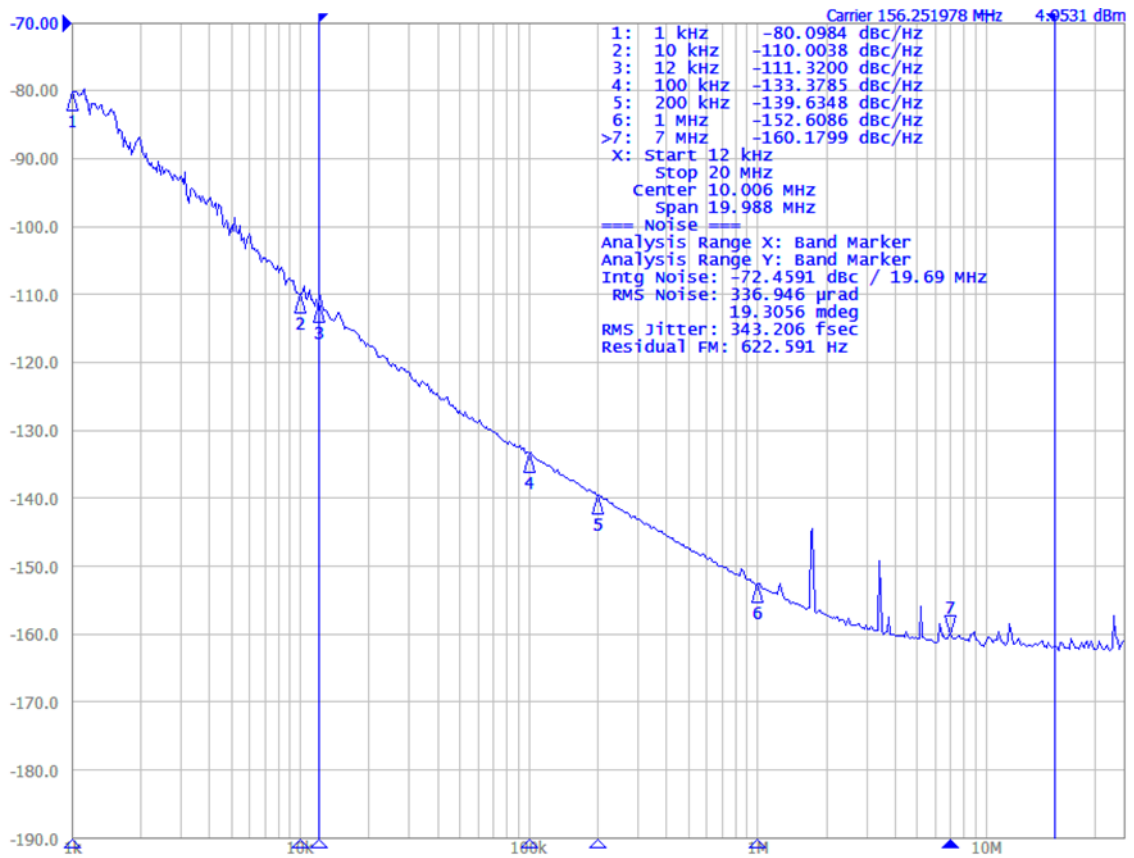

Figure 3.1. Phase Noise at 156.25 MHz

**Table 3.3. PCI-Express Clock Outputs (100 MHz HCSL)**

VDD = 1.8 V, 2.5 or 3.3 V ± 5%, TA = -40 to 105 °C

Parameter	Test Condition	Specification	Max	Units
PCIe Gen 1.1	Includes PLL BW 1.5 - 22 MHz Peaking = 3dB, T <sub>D</sub> =10 ns	N/A	0.311	ps
PCIe Gen 2.1	Includes PLL BW 5MHz & 8 - 16 MHz Peaking = 0.01 - 1 dB & 3 dB, T <sub>D</sub> =12ns Low Band, F < 1.5 MHz	3.1	0.022	ps
	Includes PLL BW 5MHz & 8 - 16 MHz Peaking = 0.01 - 1 dB & 3 dB, T <sub>D</sub> =12ns High Band, 1.5 MHz < F < Nyquist	3.0	0.259	ps
PCIe Gen 3.0 Common Clock	Includes PLL BW 2 - 4 MHz & 5 MHz Peaking = 0.01 - 2dB & 1dB, T <sub>D</sub> =12 ns CDR = 10 MHz	1	0.085	ps
PCIe Gen 4.0 Common Clock	Includes PLL BW 2 - 4 MHz & 5 MHz Peaking = 0.01 - 2dB & 1dB, T <sub>D</sub> =12 ns CDR = 10 MHz	0.5	0.085	ps
PCIe Gen 5.0 Common Clock	Includes PLL BW 500 kHz - 1.8 MHz Peaking = 0.01 - 2dB, T <sub>D</sub> =12 ns CDR = 20 MHz	0.15	0.033	ps
PCIe Gen 6.0 Common Clock	Includes PLL BW 500 kHz - 1 MHz Peaking = 0.01 - 2dB, T <sub>D</sub> =12 ns CDR = 10 MHz	0.1	0.021	ps

Class	Data Rate	Architecture	Specs	Max HF RMS	Max LF RMS	Max Pk-Pk	Compliance Summary
GEN1	2.5 Gb/s	Common Clock	1.1 2.1 3.1	310.77 fs	41.59 fs	N/A	N/A
GEN2	5 Gb/s	Common Clock	1.1 2.1 3.1	259.42 fs	21.89 fs	N/A	All PASS
GEN3	8 Gb/s	Common Clock	3.1 4.0	84.54 fs	4.68 fs	N/A	All PASS
GEN4	16 Gb/s	Common Clock	4.0	84.54 fs	4.68 fs	N/A	All PASS
GEN5	32 Gb/s	Common Clock	5.0	32.92 fs	2.09 fs	N/A	All PASS
GEN6	64 Gb/s	Common Clock	6.0	21.00 fs	0.88 fs	N/A	All PASS

**Figure 3.2. PCI-Express clock Compliance Summary**

Table 3.4. Environmental Compliance and Package Information

Parameter	Test Condition
Moisture Sensitivity Level	2

**Notes:**  
For additional product information not listed in the data sheet (e.g. RoHS Certifications, MSDS data, qualification data, REACH Declarations, ECCN codes, etc.), contact [aeonsemi.com/contact\\_us](http://aeonsemi.com/contact_us)

Table 3.5. Thermal Conditions

Package	Parameter	Symbol	Test Condition	Value	Unit
5032 6-pin DFN	Thermal Resistance Junction to Ambient	$\Theta_{JA}$	Still Air	105	°C/W
	Thermal Resistance Junction to Board	$\Theta_{JB}$	Still Air	81	°C/W
	Max Junction Temperature	$T_J$	Still Air	125	°C
3225 6-pin DFN	Thermal Resistance Junction to Ambient	$\Theta_{JA}$	Still Air	108	°C/W
	Thermal Resistance Junction to Board	$\Theta_{JB}$	Still Air	84	°C/W
	Max Junction Temperature	$T_J$	Still Air	125	°C

Table 3.6. Absolute Maximum Ratings<sup>1</sup>

Parameter	Symbol	Rating	Unit
Maximum Operating Temp	$T_{AMAX}$	105	°C
Storage Temperature	$T_S$	-55 to 105	°C
Supply Voltage	$V_{DD}$	-0.5 to 3.8	V
Input Voltage	$V_{IN}$	-0.5 to $V_{DD} + 0.3$	V
ESD HBM (JESD22-A114)	HBM	4.0	kV
ESD CDM (JESD22-C101)	CDM	1.0	kV
Solder Temperature <sup>2</sup>	$T_{PEAK}$	260	°C
Solder Time at $T_{PEAK}$ <sup>2</sup>	$T_P$	20 - 40	sec

**Notes:**

1. Stresses beyond those listed in this table may cause permanent damage to the device. Functional operation specification compliance is not implied at these conditions. Exposure to maximum rating conditions for extended periods may affect device reliability.

2. The device is compliant with JEDEC J-STD-020.



**4. CMOS Buffer and Output Terminations**

Dual CMOS output format ordering options support either complementary or in-phase signals for two identical frequency outputs. This feature enables replacement of multiple XOs with a single AS5002 device.

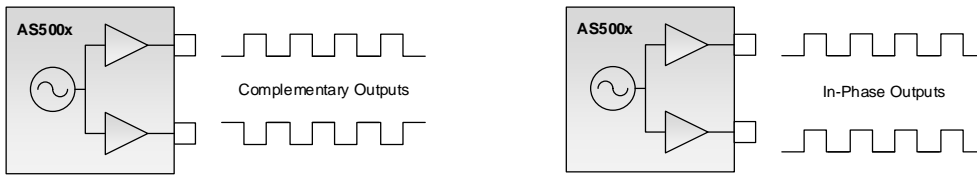

**Figure 4.1. Integrated 1:2 CMOS Buffer Supports In-Phase or Complementary Outputs**

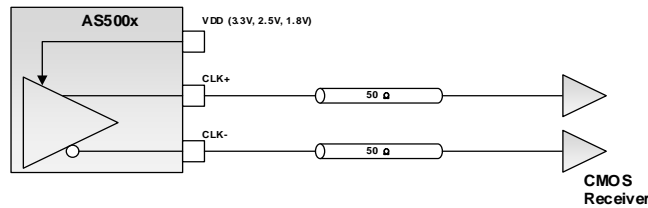

**Figure 4.2. Dual CMOS termination**

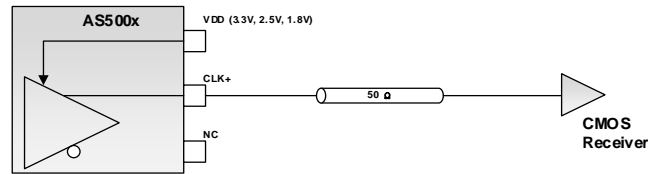

**Figure 4.3. Single CMOS termination**

## 5. Recommended Output Terminations

The output drivers support AC-coupled or DC-coupled terminations as shown in figures below.

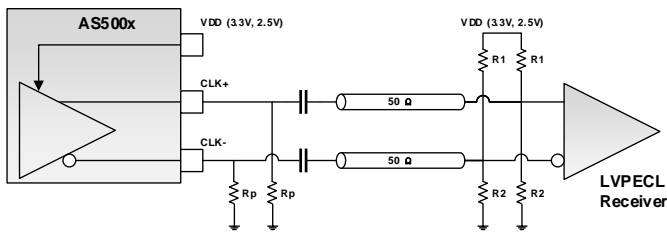

AC-Coupled LVPECL - Thevenin Termination

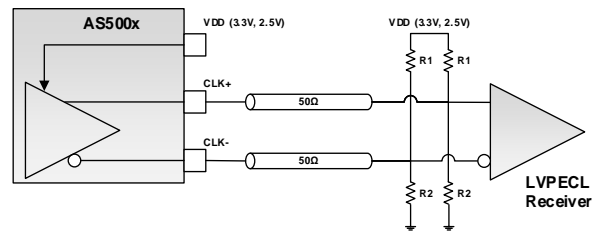

DC-Coupled LVPECL - Thevenin Termination

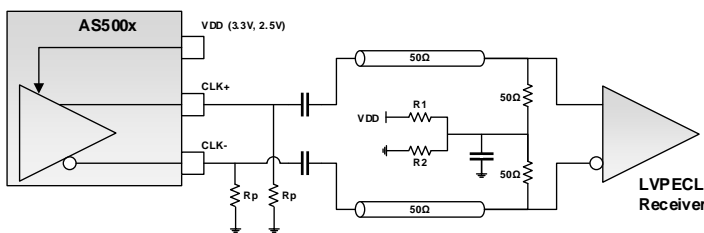

AC-Coupled LVPECL - 50 Ω w/VTT Bias

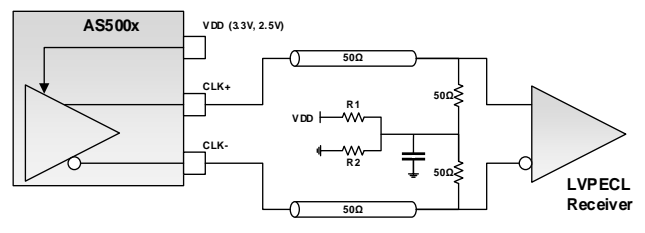

DC-Coupled LVPECL - 50 Ω w/VTT Bias

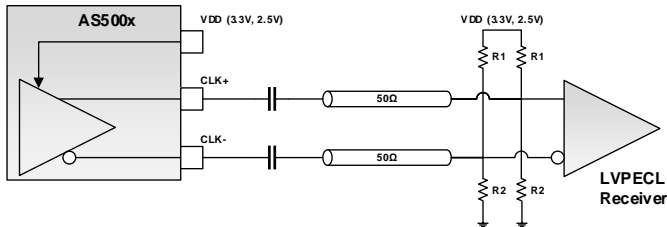

AC-Coupled Self-Biased LVPECL - Thevenin Termination

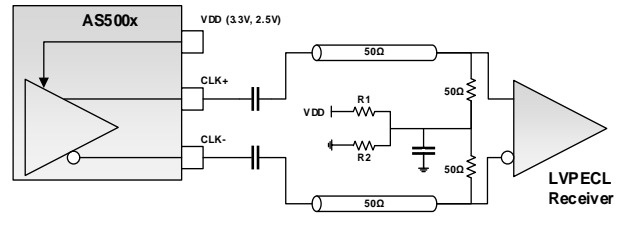

AC-Coupled Self-Biased LVPECL - 50 Ω w/VTT Bias

Figure 5.1. LVPECL Output Terminations

Table 5.1. LVPECL Termination Resistor Values

AC Coupled LVPECL Termination Resistor Values			
V <sub>DD</sub>	R <sub>p</sub>	R <sub>1</sub>	R <sub>2</sub>
3.3 V	158 Ω	127 Ω	82.5 Ω
2.5 V	92 Ω	250 Ω	62.5 Ω

DC Coupled LVPECL Termination Resistor Values		
V <sub>DD</sub>	R <sub>1</sub>	R <sub>2</sub>
3.3 V	127 Ω	82.5 Ω
2.5 V	250 Ω	62.5 Ω

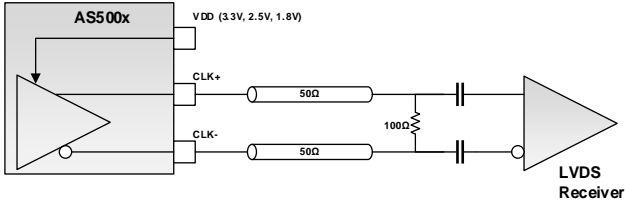

**AC-Coupled LVDS**

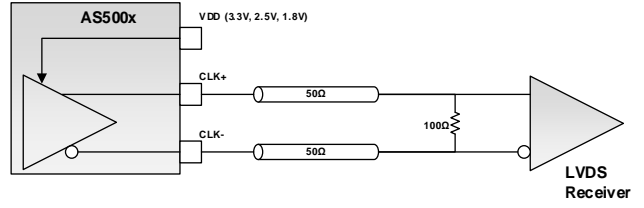

**DC-Coupled LVDS**

**Figure 5.2. LVDS Output Termination**

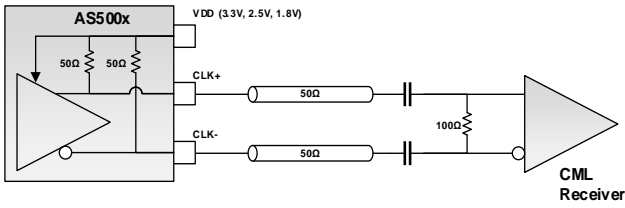

**AC-Coupled CML without VCM**

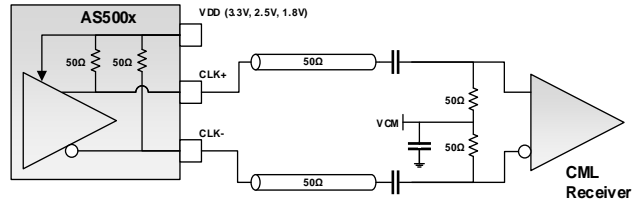

**AC-Coupled CML with VCM**

**Figure 5.3. CML Output Termination**

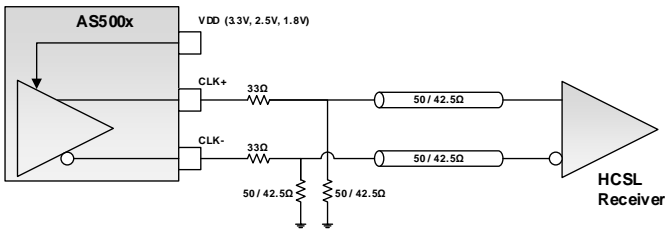

**Source Terminated HCSSL**

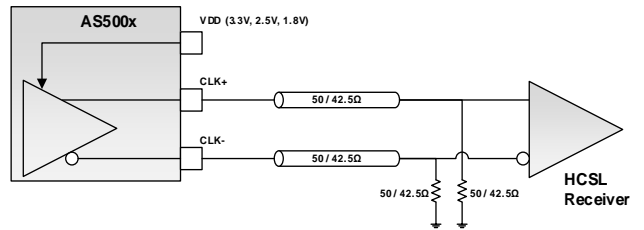

**Destination Terminated HCSSL**

**Figure 5.4. HCSSL Output Termination**

## 6. Package Outline

### 1.1. Package Outline (5032)

The figure below illustrates the package details for the AS5002 devices in 5032 package. The table below lists the values for the dimensions shown in the illustration.

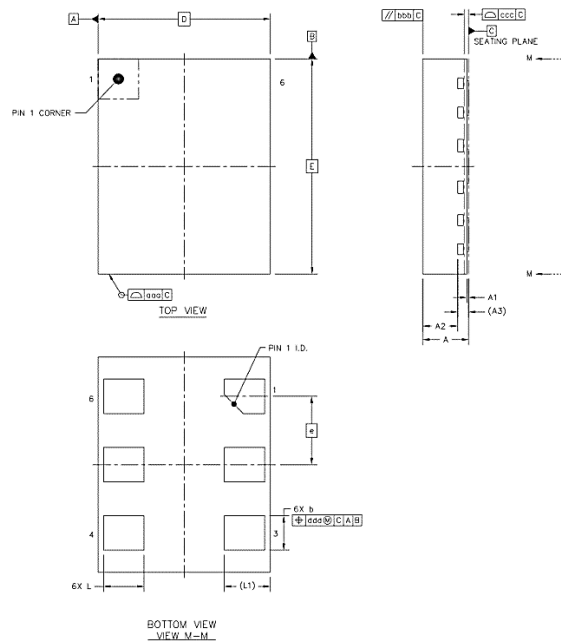

**Figure 6.1. AS5002 5032 Package Outline Diagram**

**Table 6.2. Package Diagram Dimensions (mm)**

Symbol	Min	Nom	Max
A	0.8	0.85	0.9
A1	0	0.035	0.05
A2	---	0.65	---
A3	0.203 REF		
b	0.59	0.64	0.69
D	3.1	3.2	3.3
E	3.9	4	4.1
e	1.27 BSC		
L	0.7	0.75	0.8
L1	0.85 REF		
aaa	0.1		
bbb	0.1		
ccc	0.08		
ddd	0.1		

**Notes:**

1. All dimensions shown are in millimeters (mm) unless otherwise noted.
2. Dimensioning and Tolerancing per ANSI Y14.5M-1994.

**1.2. Package Outline (3225)**

The figure below illustrates the package details for the AS5002 devices in 3225 package. The table below lists the values for the dimensions shown in the illustration.

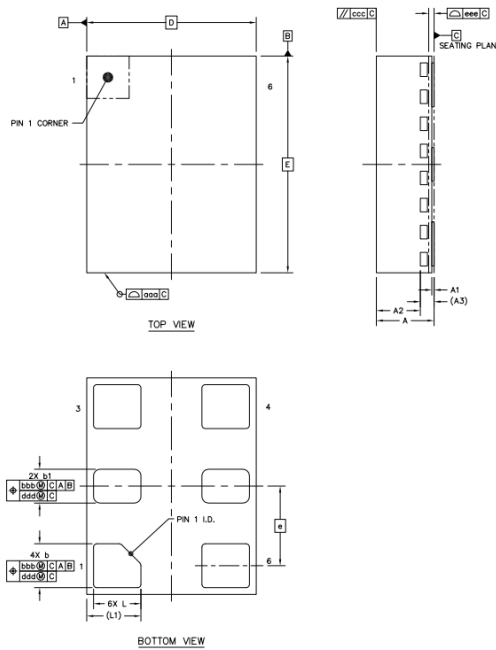

**Figure 1.1. AS5002 3225 Package Outline Diagram**

**Table 1.1. Package Diagram Dimensions (mm)**

Symbol	Min	Nom	Max
A	0.8	0.85	0.9
A1	0	0.035	0.05
A2	---	0.65	---
A3	0.203 REF		
b	0.6	0.65	0.7
b1	0.45	0.5	0.55
D	2.4	2.5	2.6
E	3.1	3.2	3.3
e	1.175 BSC		
L	0.65	0.7	0.75
L1	0.8 REF		
aaa	0.1		
bbb	0.07		
ccc	0.1		
ddd	0.05		
eee	0.08		

**Notes:**

1. All dimensions in millimeters (mm).
2. Dimensioning and Tolerancing per ANSI Y14.5M-1994.

## 7. PCB Land Pattern (5032 and 3225 package)

The figure below illustrates the PCB land pattern for the AS5002. The table below lists the values for the dimensions shown in the illustration.

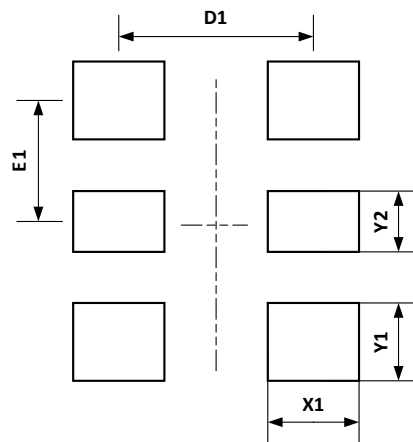

Figure 7.1. AS5002 (5032 and 3225 package) PCB Land Pattern

Table 7.2. PCB Land Pattern Dimensions (mm)

Dimension	Description	5032 Package Value (mm)	3225 Package Value (mm)
X1	Width - leads on long sides	0.80	0.75
Y1	Height - leads on long sides	0.69	0.7
Y2	Height - leads on long sides	0.69	0.55
D1	Pitch in X directions of XLY1 leads	2.30	1.65
E1	Lead pitch XLY1 leads	1.27	1.175

**Notes:**

The following notes and stencil design are shared as recommendations only. A customer or user may find it necessary to use different parameters and fine-tune their SMT process as required for their application and tooling.

**General**

1. All dimensions shown are in millimeters (mm) unless otherwise noted.
2. Dimensioning and Tolerancing is per the ANSI Y14.5M-1994 specification.
3. This Land Pattern Design is based on the IPC-7351 guidelines.
4. All dimensions shown are at Maximum Material Condition (MMC). Least Material Condition (LMC) is calculated based on a Fabrication Allowance of 0.05 mm.

**Solder Mask Design**

1. All metal pads are to be non-solder mask defined (NSMD). Clearance between the solder mask and the metal pad is to be 60 μm minimum, all the way around the pad.

**Stencil Design**

1. A stainless steel, laser-cut and electro-polished stencil with trapezoidal walls should be used to assure good solder paste release.
2. The stencil thickness should be 0.125 mm (5 mils).
3. The ratio of stencil aperture to land pad size should be 0.8:1 for the pads.

**Card Assembly**

1. A No-Clean, Type-3 solder paste is recommended.
2. The recommended card reflow profile is per the JEDEC/IPC J-STD-020 specification for Small Body Components.

**8. Top Marking (5032 and 3225 Package)**

The figure below illustrates the mark specification for the AS5002. The table below lists the line information.

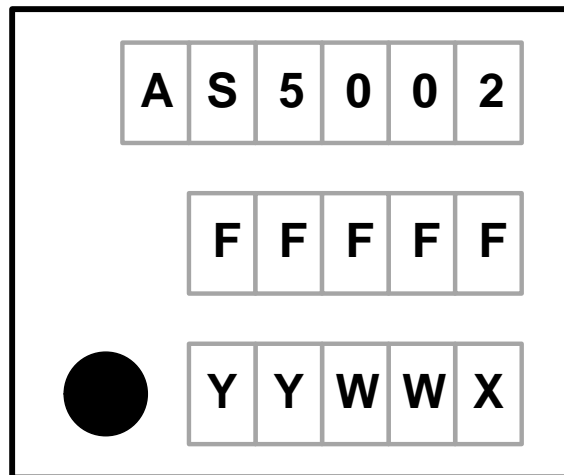

**Figure 8.1. AS5002 Top Mark**

**Table 8.2. AS5002 Top Mark Description**

Line	Position	Description
1	1-6	Device Name
2	1-5	Unique 5-digit Device Configuration Number
3	Position 1	Pin 1 orientation mark (dot)
	Position 2-3	Year (last two digits of the year), to be assigned by assembly site (ex: 2017 = 17)
	Position 4-5	Calendar Work Week number (1-53), to be assigned by assembly site
	Position 6	Assembly site code

## 9. IMPORTANT NOTICE AND DISCLAIMER

Aeonsemi provides technical information such as datasheets, characterization reports, application notes, reference designs, and other resources “as is” and with all faults, and disclaims all warranties, express and implied, including without limitation any implied warranties of merchantability, fitness for a particular purpose or non-infringement of third-party intellectual property rights. These resources are subject to change without notice except when PCN is applicable. Aeonsemi grants you permission to use these resources only for development of an application that uses the Aeonsemi products described in the resource. Other reproduction and display of these resources are prohibited. No license is granted to any other Aeonsemi intellectual property right or to any third-party intellectual property right. Aeonsemi disclaims responsibility for, and you will fully indemnify Aeonsemi and its representatives against, any claims, damages, costs, losses, and liabilities arising out of your use of these resources.

Aeonsemi’s products are provided subject to Aeonsemi’s Terms of Sale ([aeonsemi.com/terms](https://aeonsemi.com/terms)) or other applicable terms available either on [aeonsemi.com](https://aeonsemi.com) or provided in conjunction with such Aeonsemi products.

Contact: [marketing@aeonsemi.com](mailto:marketing@aeonsemi.com)



**10. Revision History**

Rev	Date	Description
1.10	Jul 2022	Updated the top mark specification Updated the Package Outline and PCB Land Pattern Dimensions for 3225 package Add min/max value of symbol "D" & "E" for package outline
1.01	Dec 2021	Adjusted the PCB land pattern dimensions
1.00	Sep 2021	With certain specification update
0.95	Jun 2021	Corrected the Ordering Guide Insert -40~105oC temperature range option Insert section "PCIe clock compliance" Insert section "IMPORTANT NOTICE AND DISCLAIMER"
0.94	Mar 2021	Updated the Ordering Guide
0.93	Feb 2021	Corrected the Top Mark Corrected the storage temperature
0.92	Feb 2021	Corrected the PCB Land Pattern description Corrected the Top Mark description Updated the Ordering Guide
0.91	Oct 2020	Removed Note 3 "IEEE802.3-2005 10GbE jitter mask." Corrected figure # of section 3 and section
0.90	Sep 2020	Initial release